

VICTORIA C 40

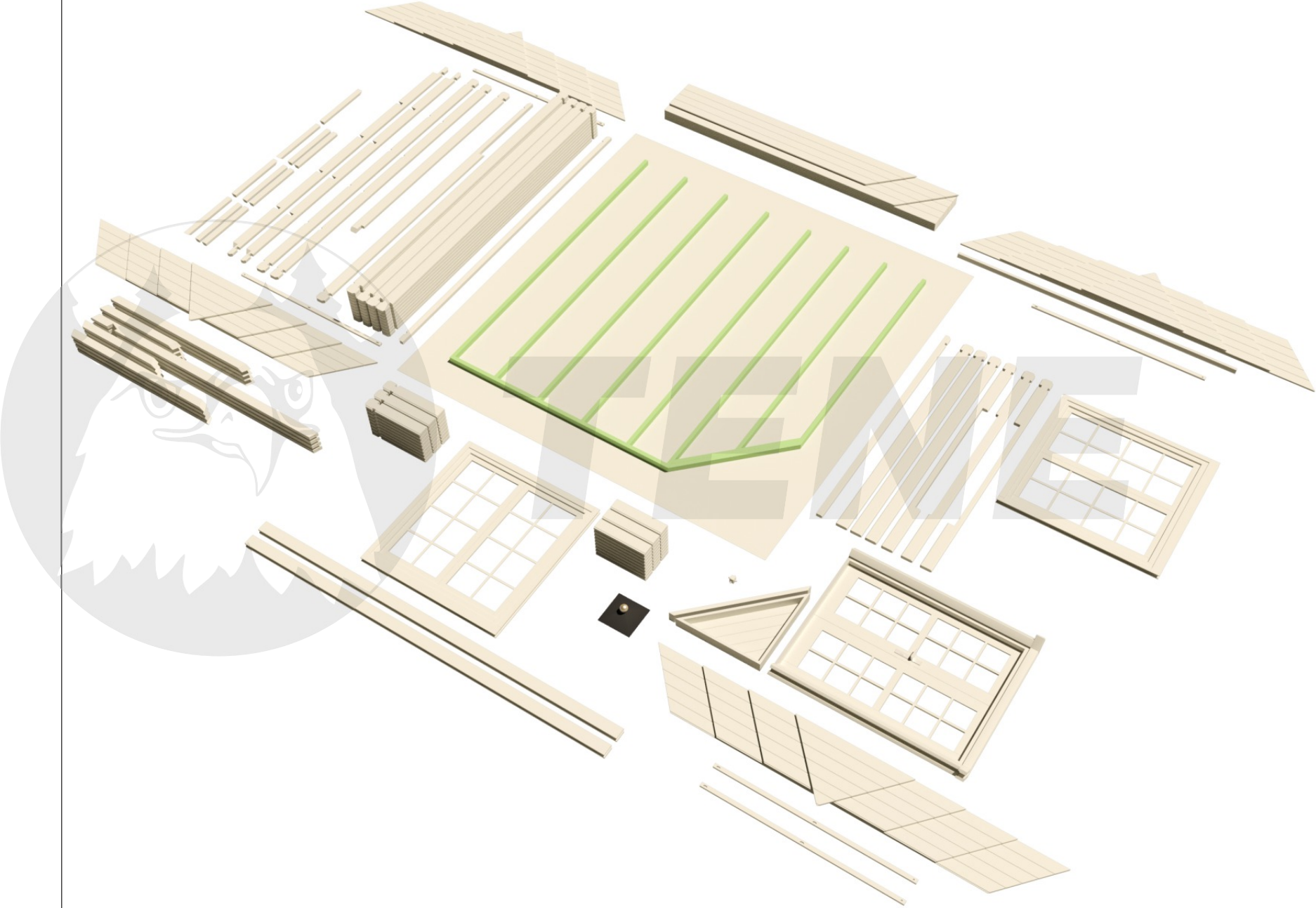

VICTORIA C 40

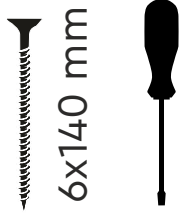

6x140 mm

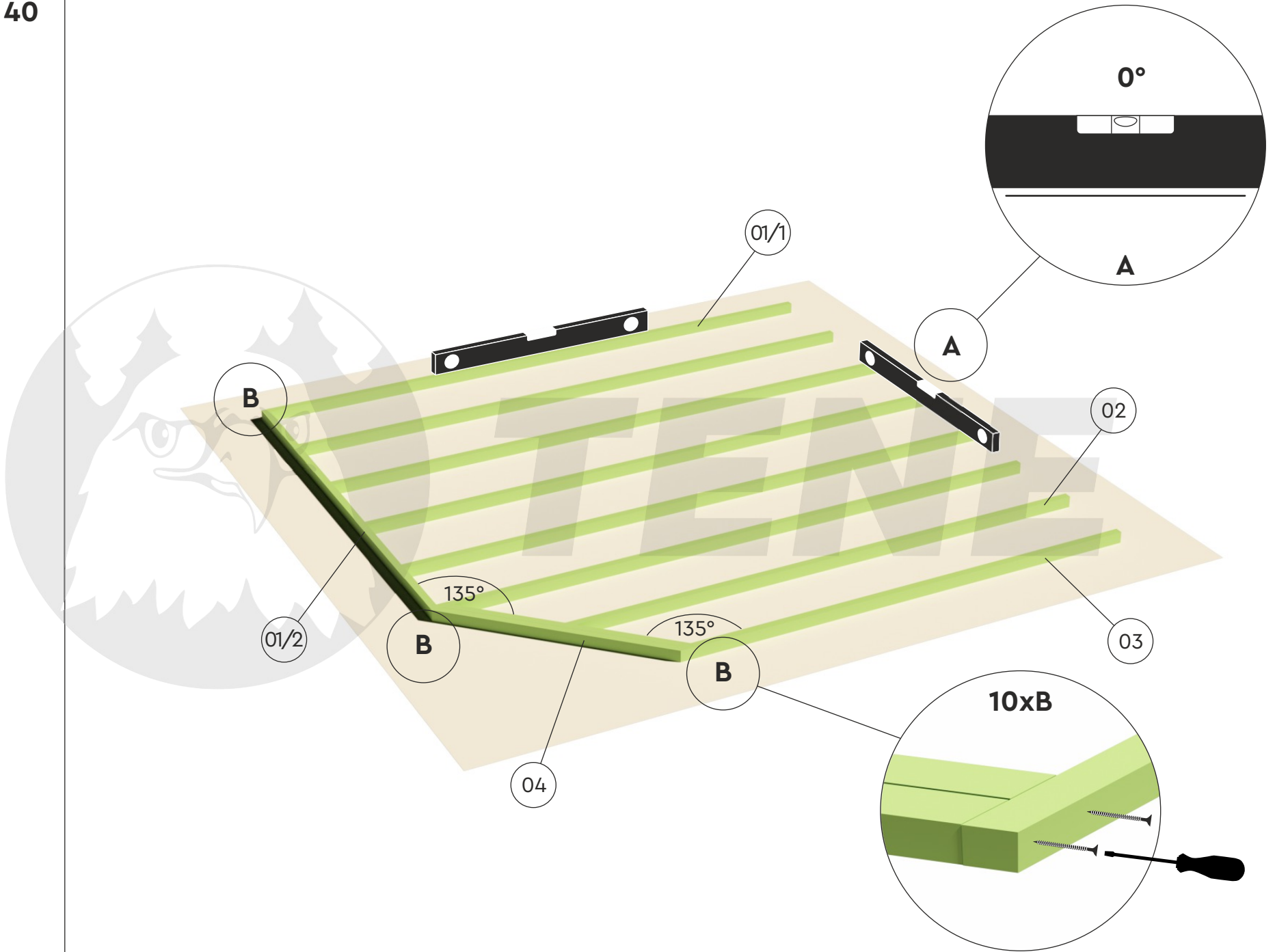

VICTORIA C 40

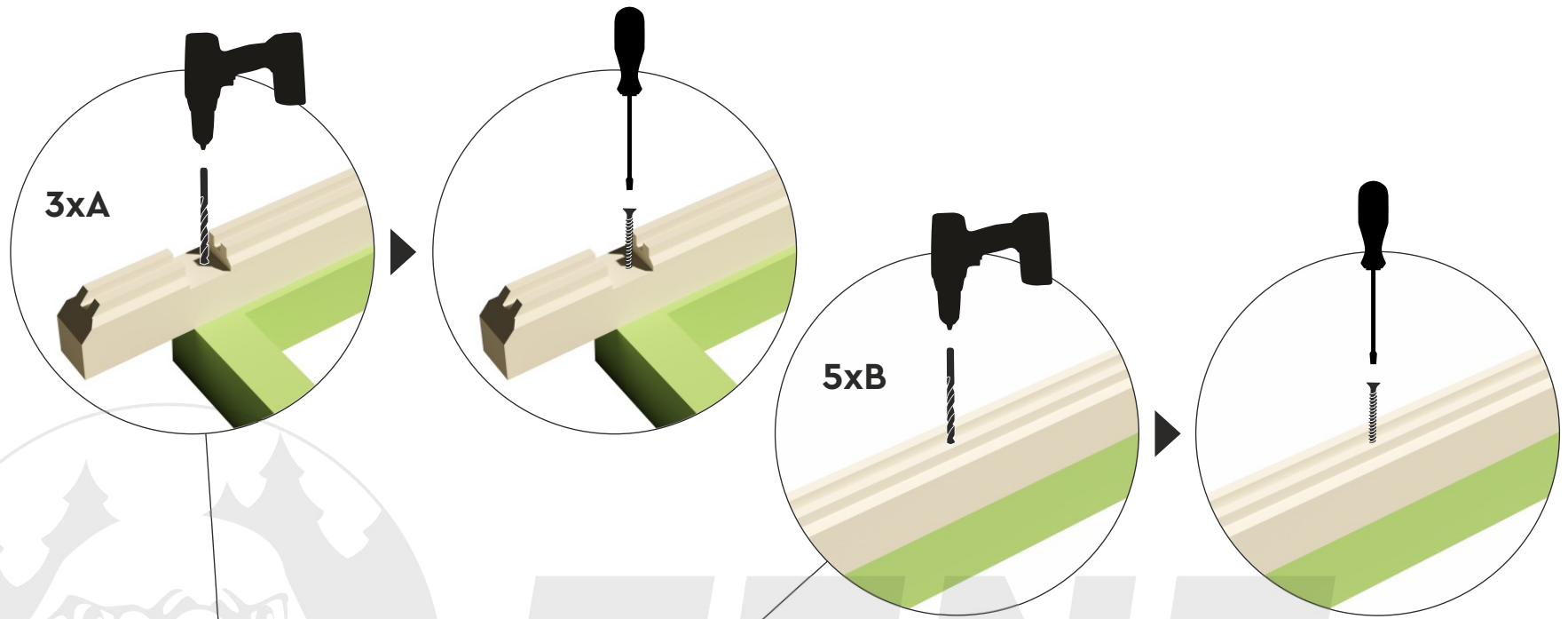

Ø 4 mm

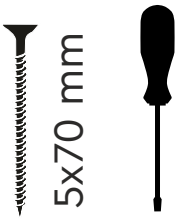

5x70 mm

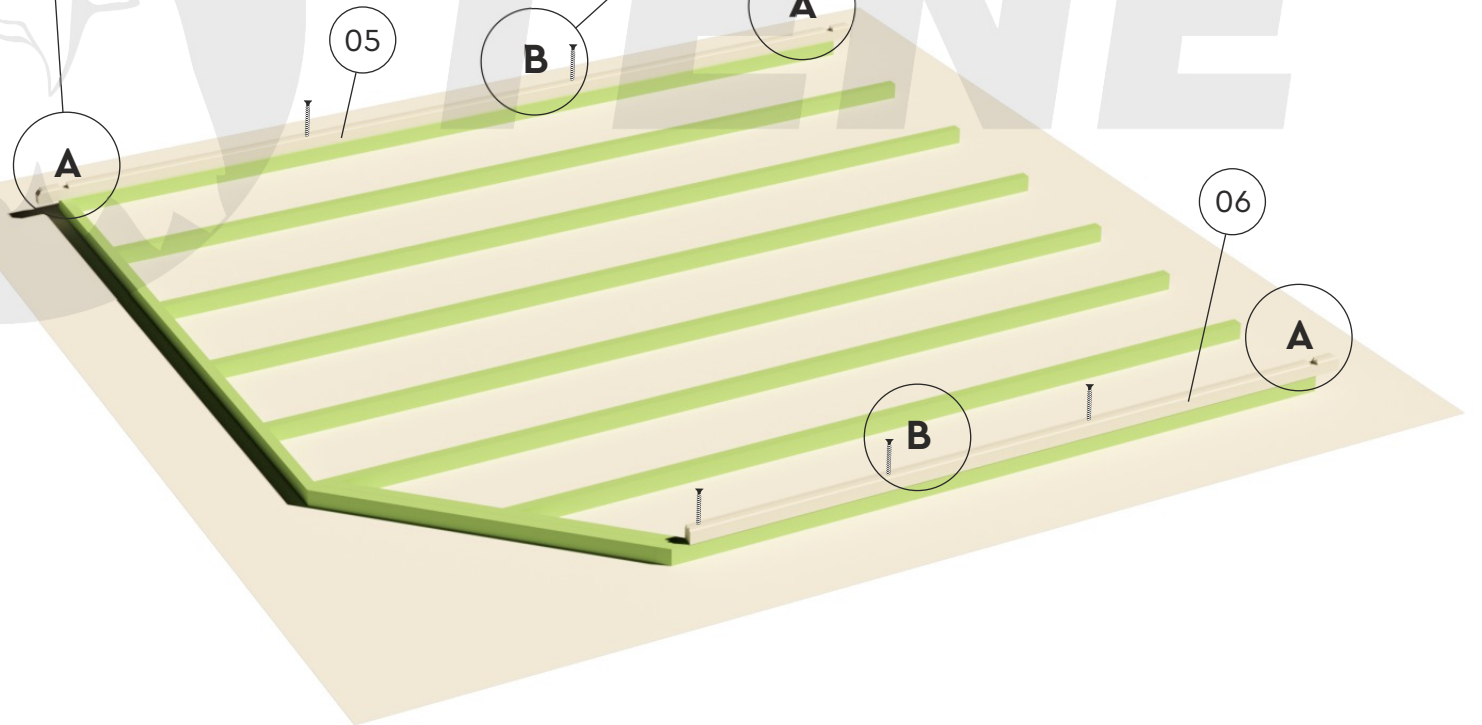

VICTORIA C 40

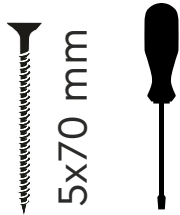
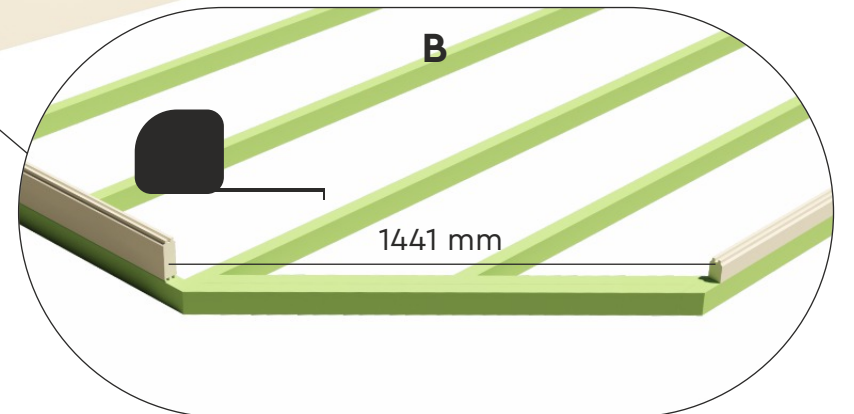
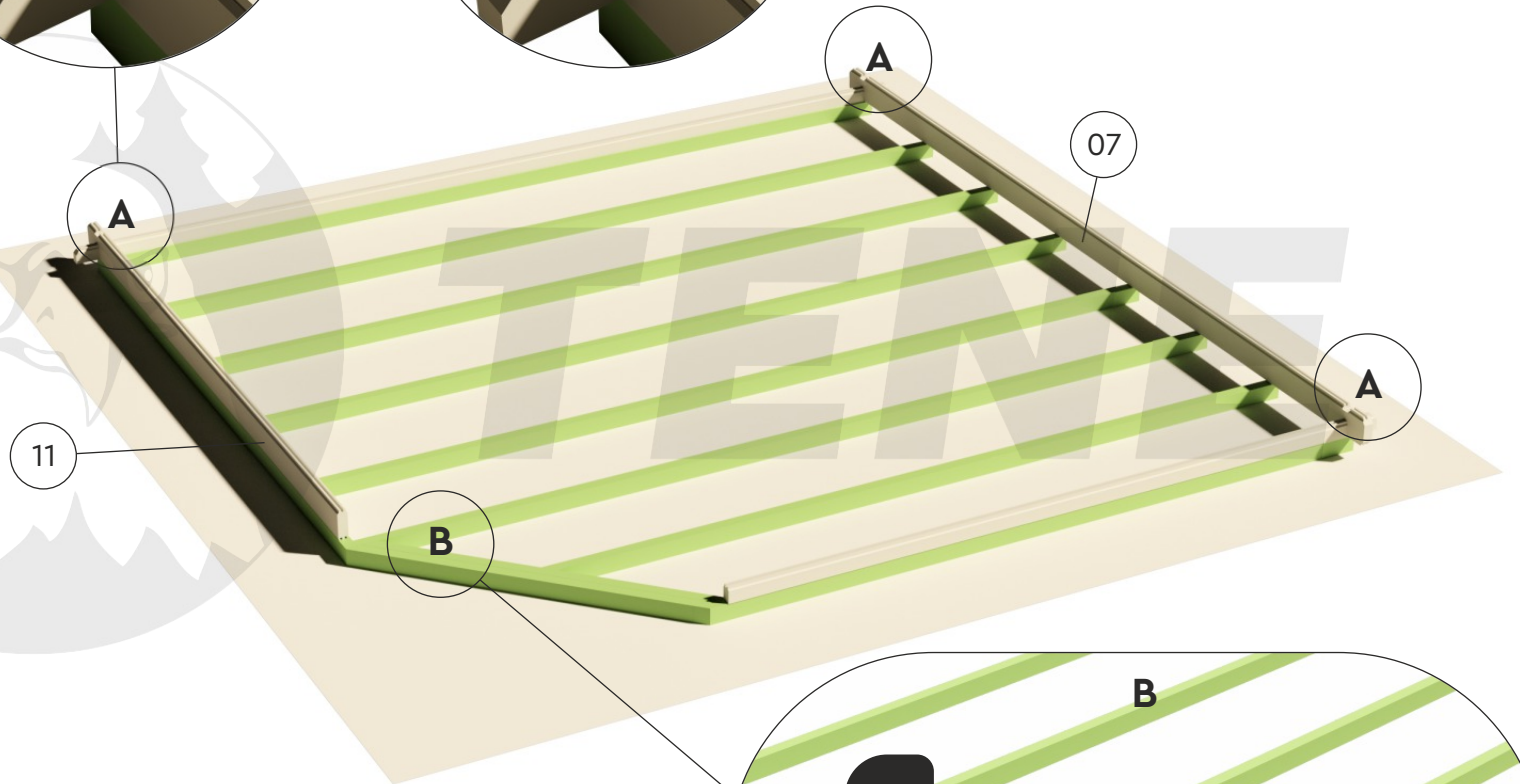
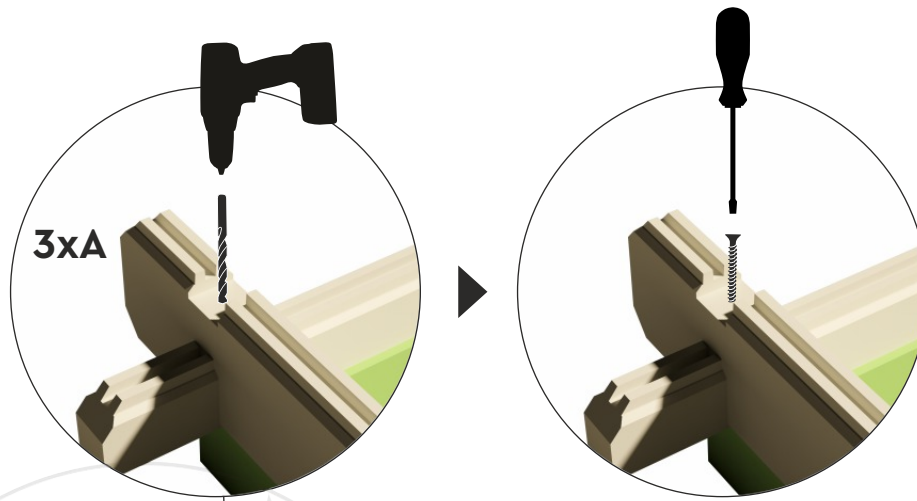

VICTORIA C 40

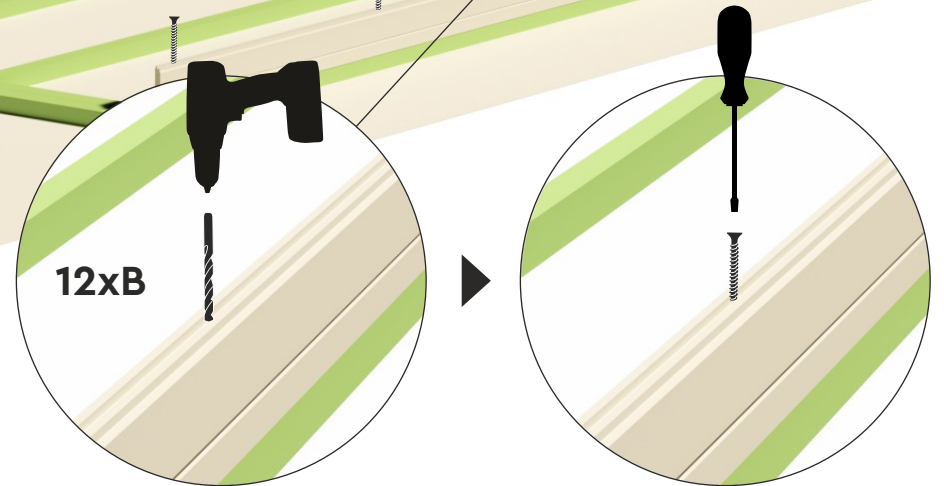
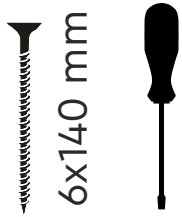
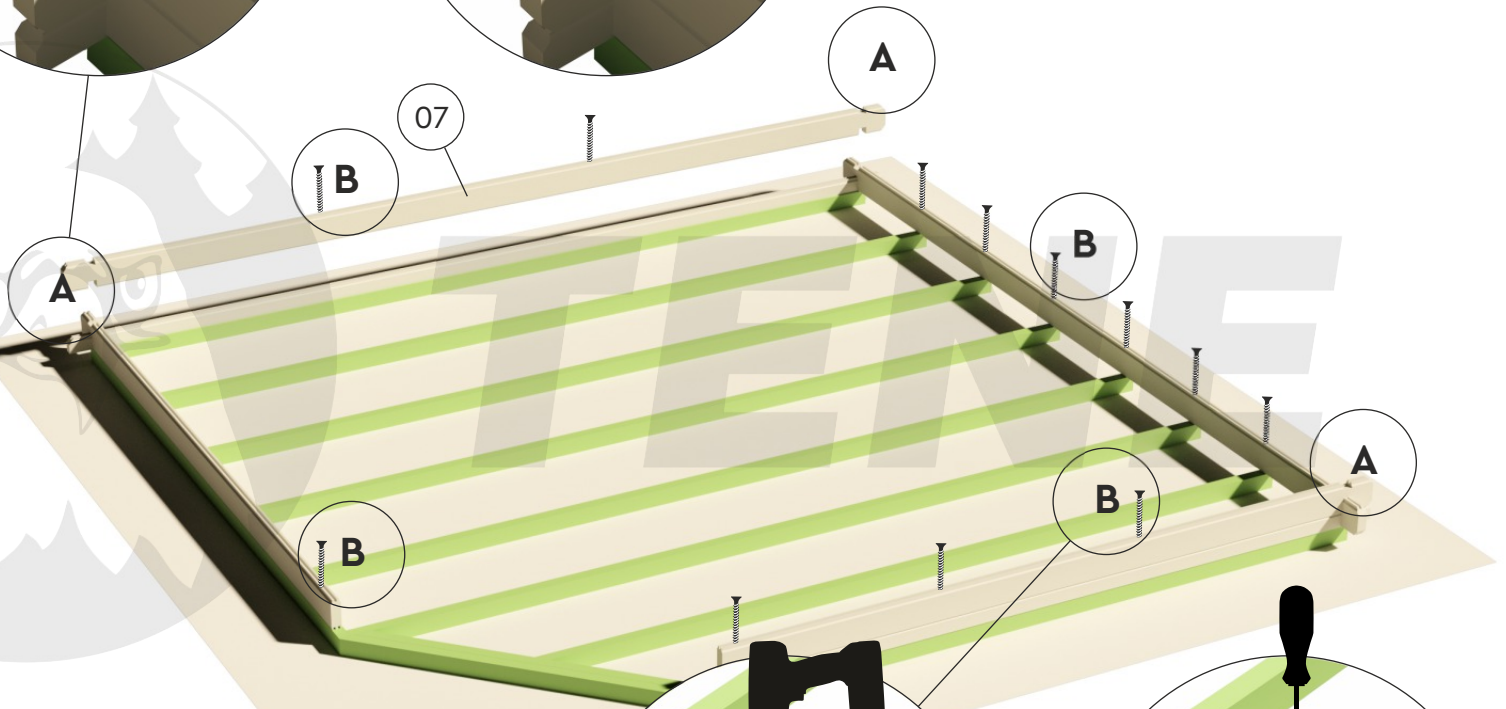
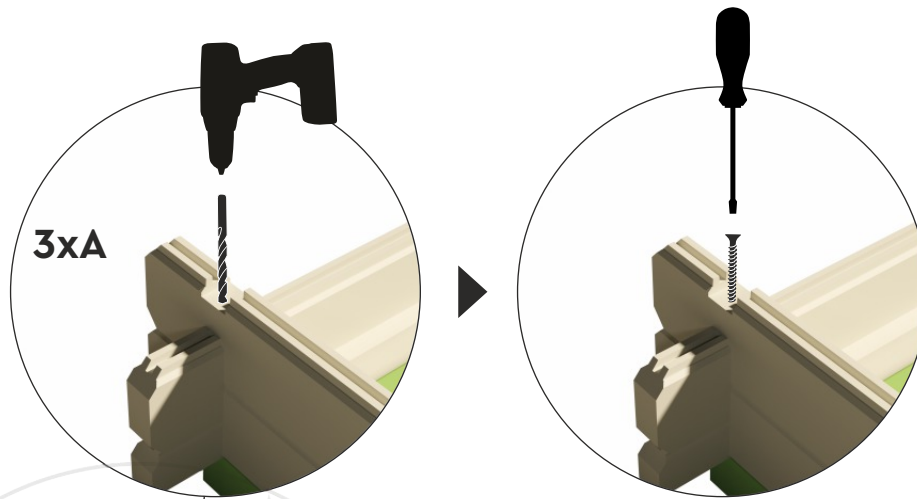

VICTORIA C 40

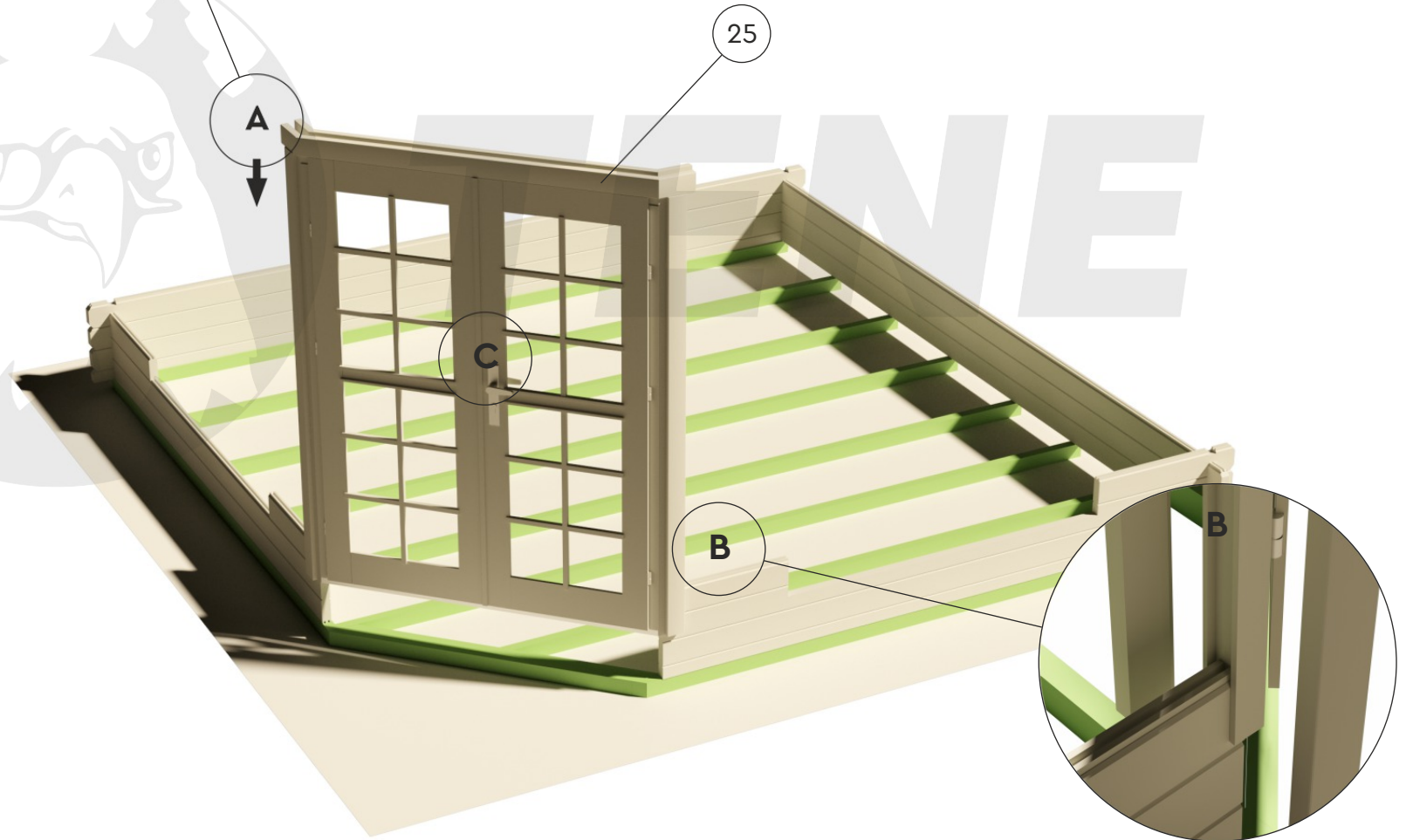
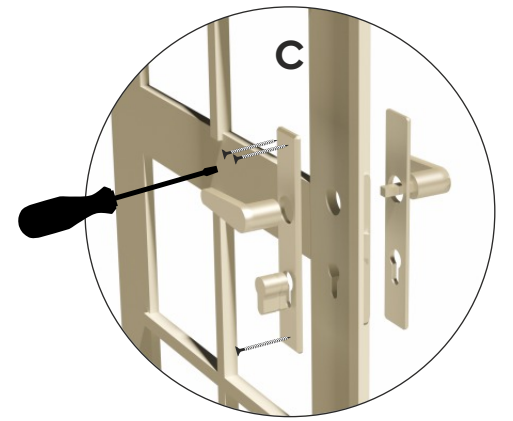
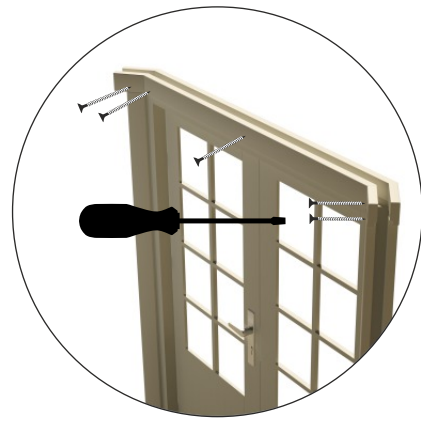
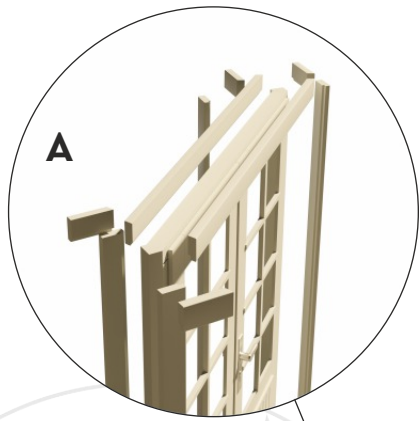

4x40 mm



VICTORIA C 40

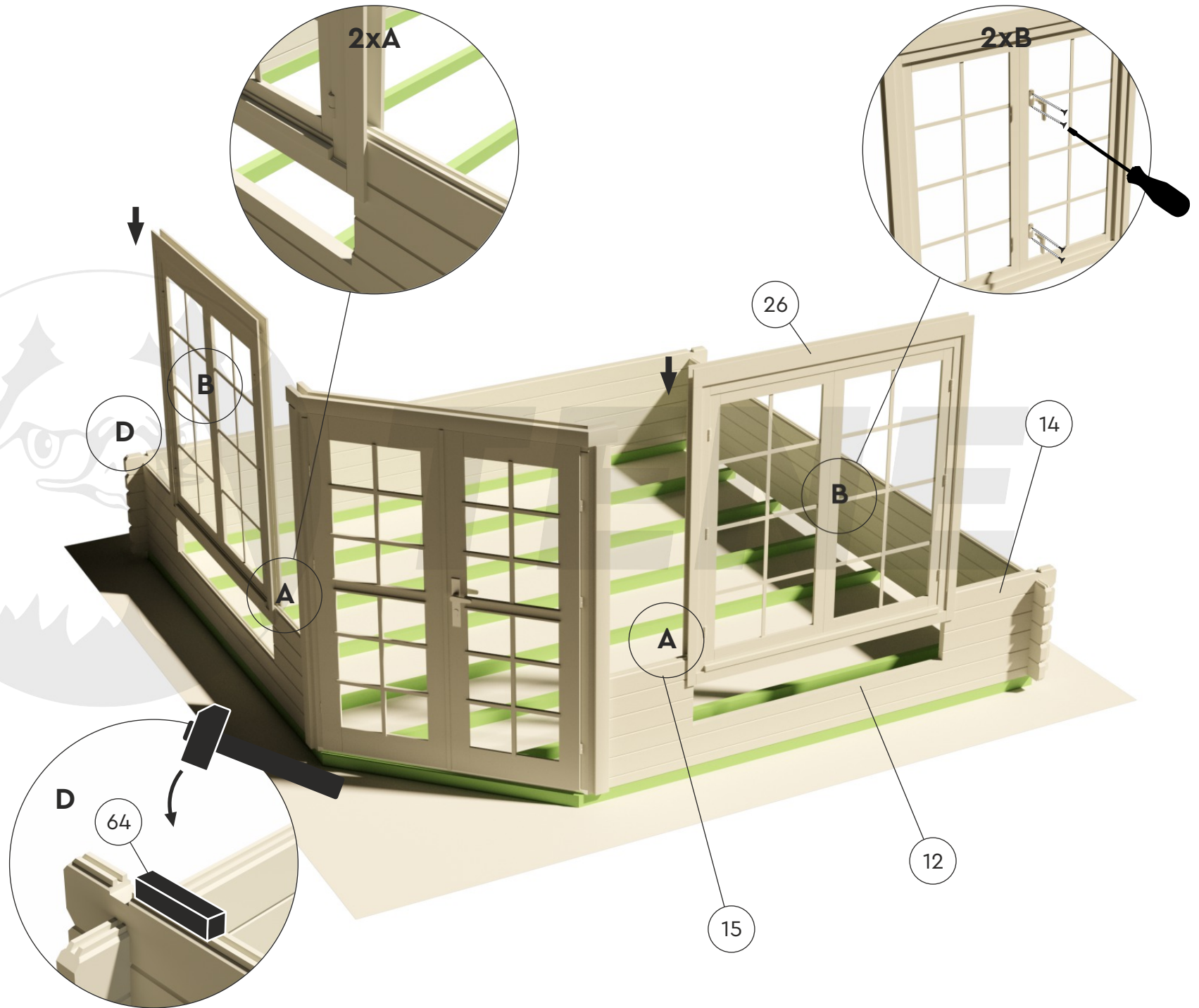
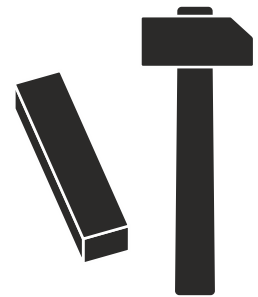

VICTORIA C 40

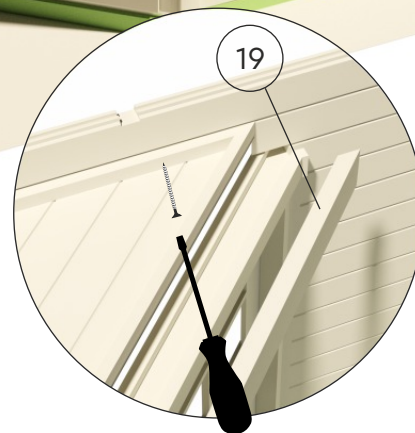
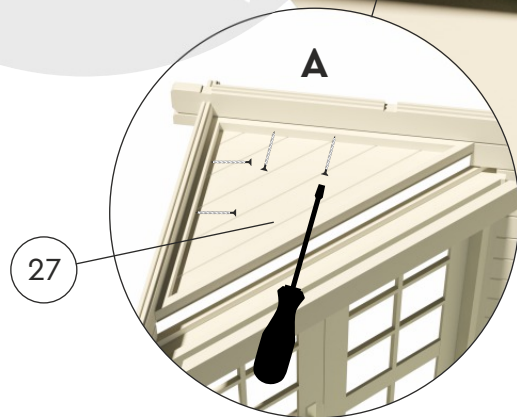
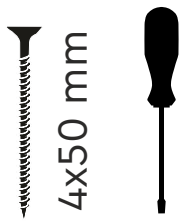

VICTORIA C 40

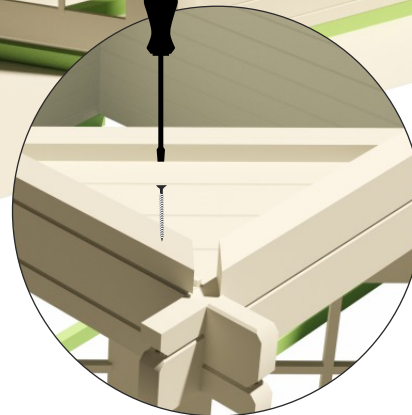
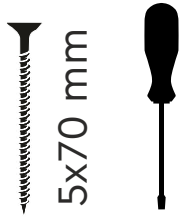
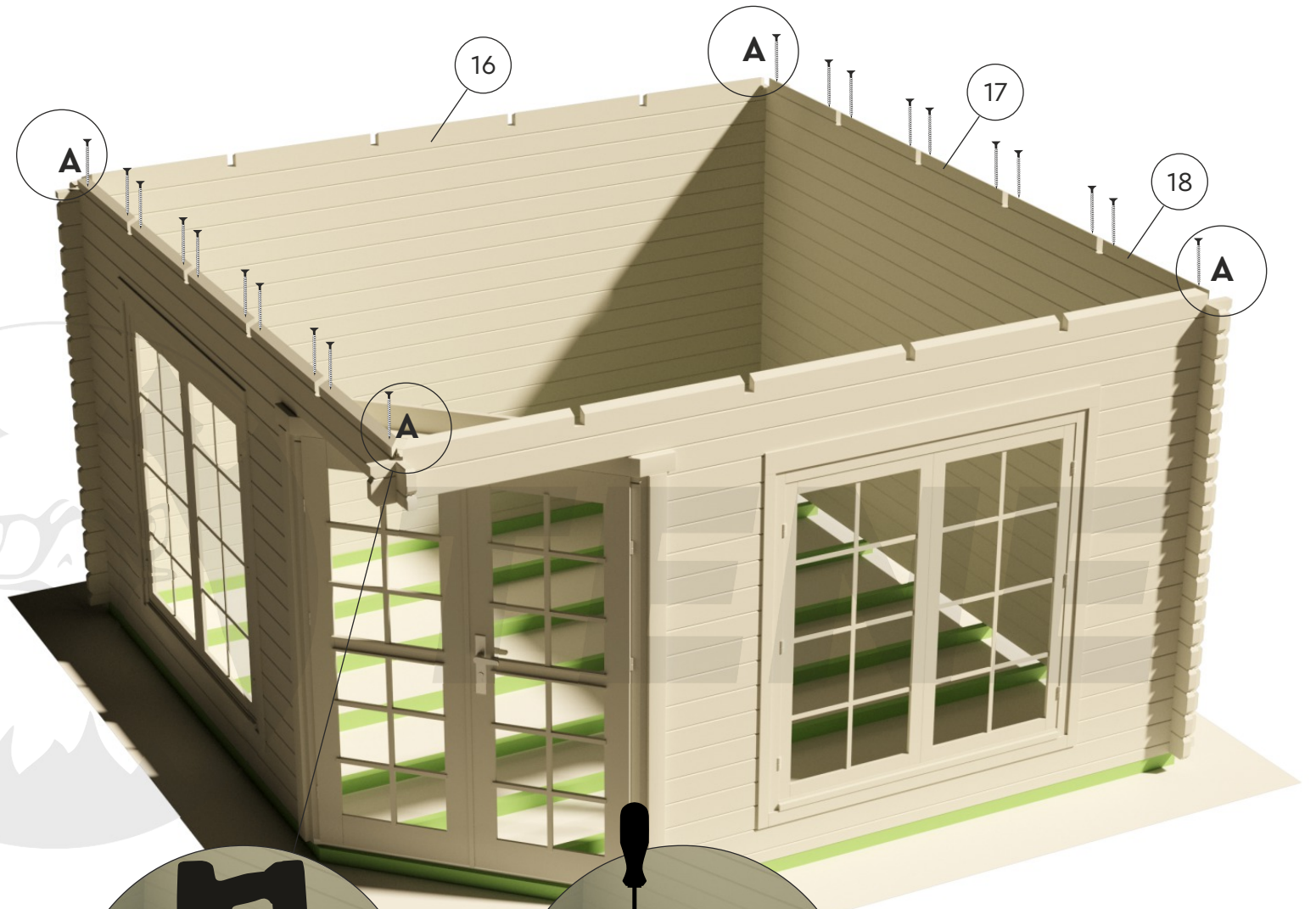

VICTORIA C 40

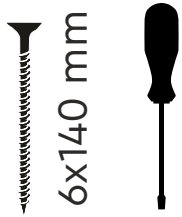
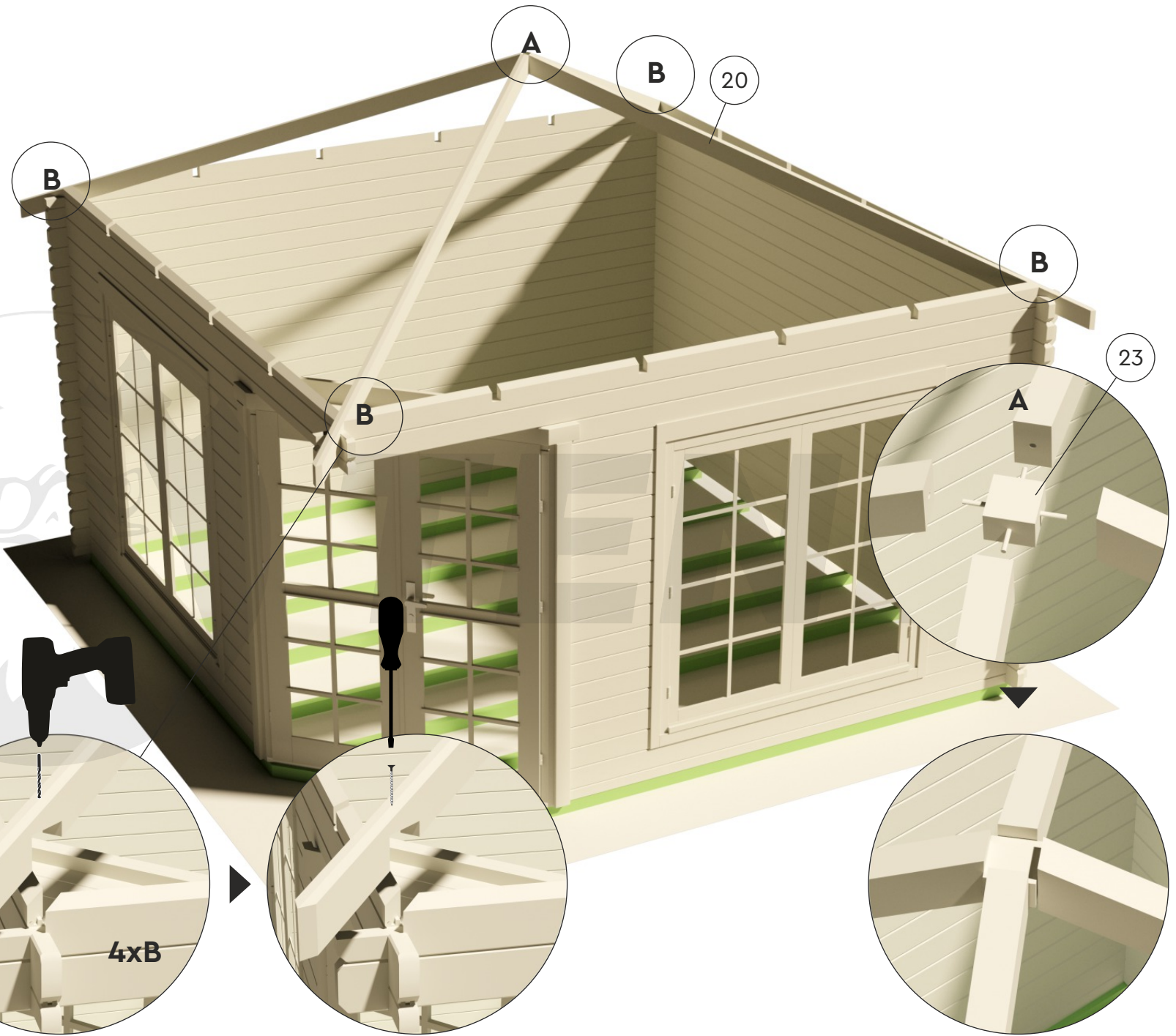

VICTORIA C 40



ø 5 mm



ø 4 mm



6x140 mm



5x70 mm

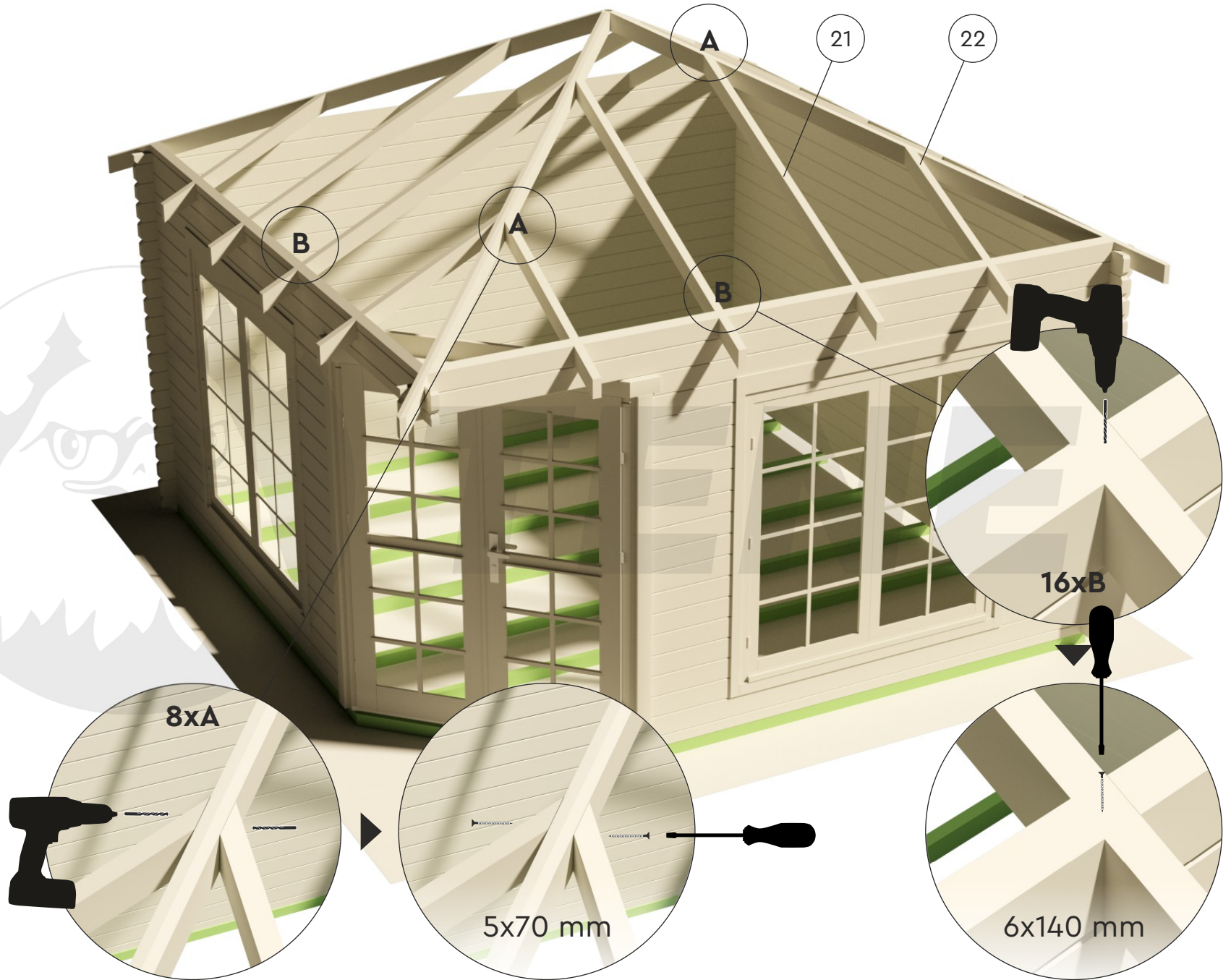

VICTORIA C 40

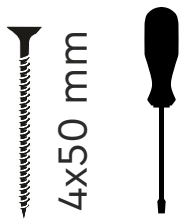
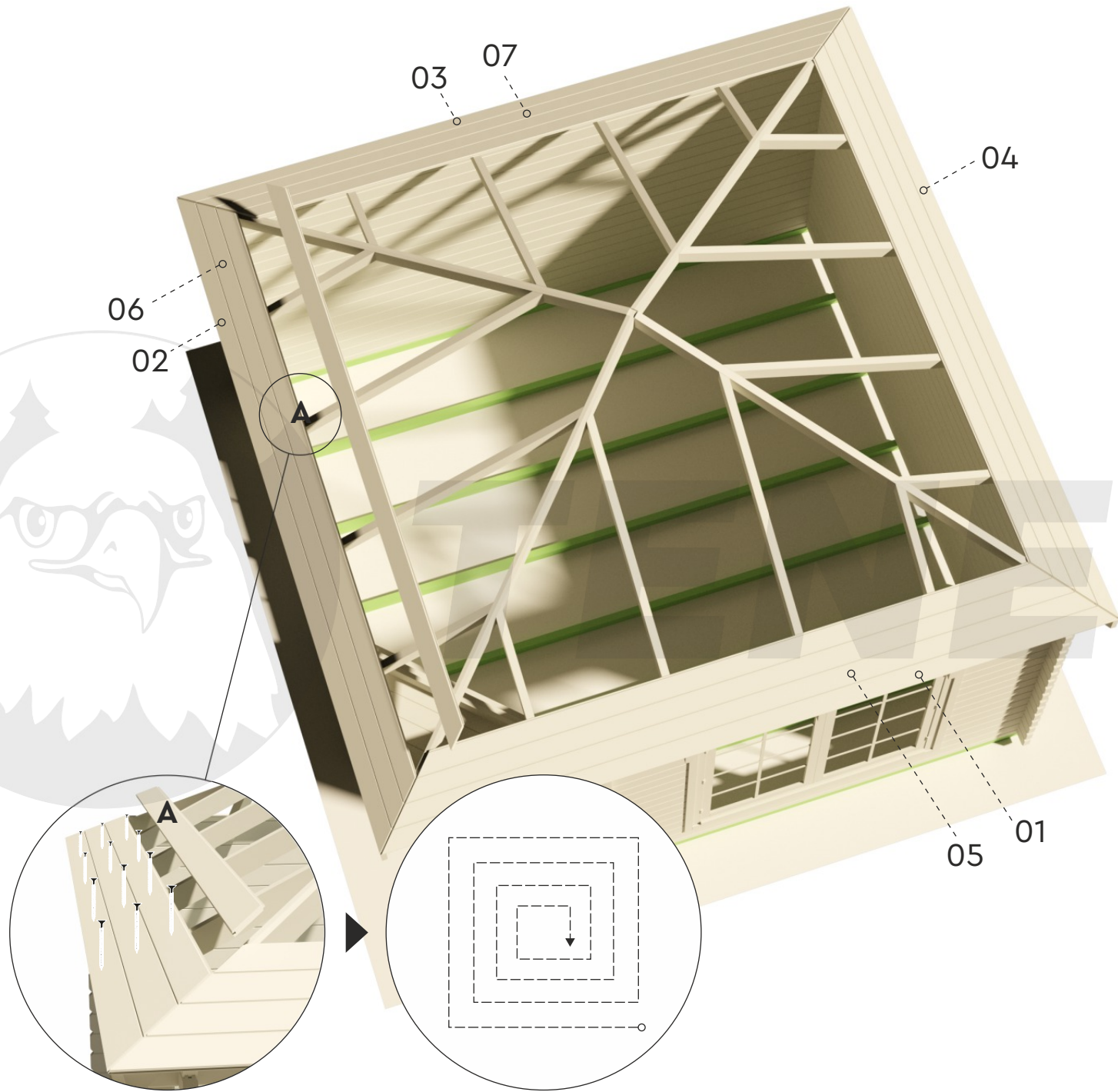

VICTORIA C 40

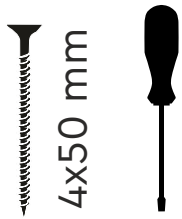
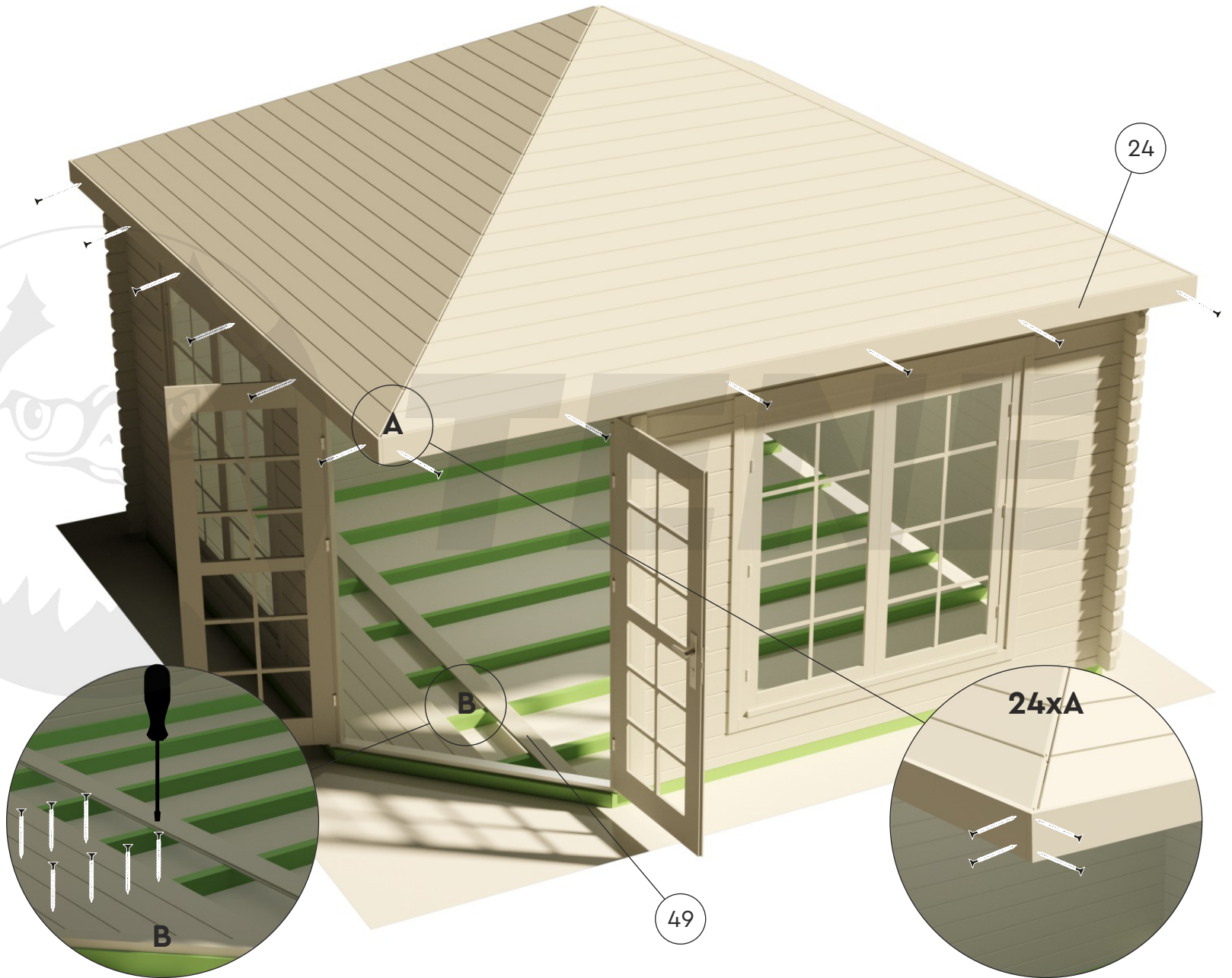

VICTORIA C 40

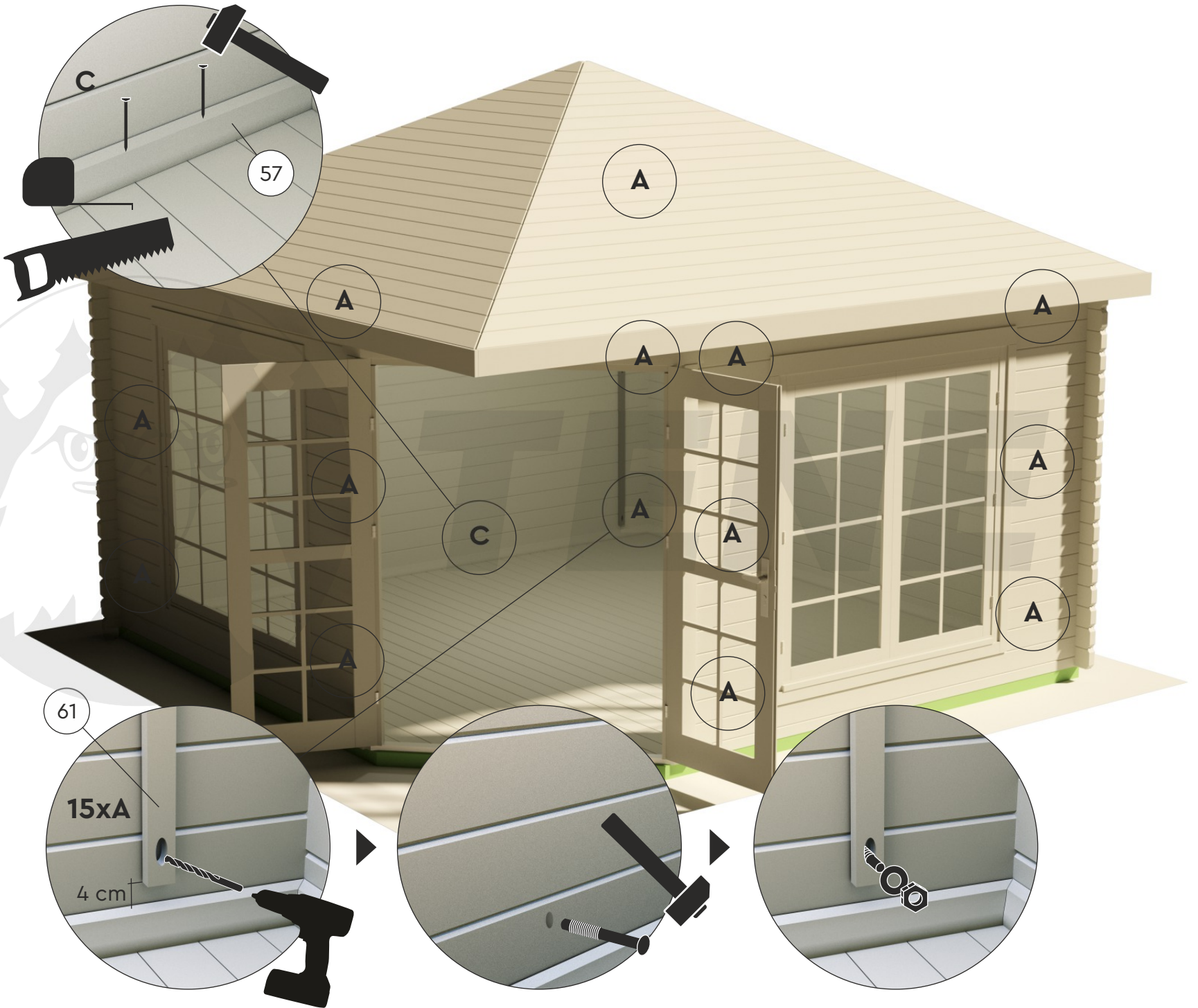

VICTORIA C 40

